

## A quick guide to the EZStepper®

Revision A 1

### For these products

- EZHR23EN48V

### You will need:

- ▶ Your EZStepper® Controller/Driver
- ▶ PC with USB port
- ▶ Power supply, +12 to 50V. For first-time EZStepper users we recommend a current-limited power supply to protect against miswiring.
- ▶ Appropriate motor (refer to data sheet for product)
- ▶ Crimp tool (recommended): T-handle crimp tool, Digikey part A9982. Otherwise, soldering equipment. (Note: alternative connectors may be used, as described in Application Note 131021, Mating Connectors for Headers.)
- ▶ Small Philips screwdriver for operating address switch on board
- ▶ If troubleshooting is required: ohmmeter, oscilloscope
- ▶ If using USB Port connection, matching USB cable (provided in starter kit)

### Precautions

- ▶ Observe all electrostatic discharge precautions to avoid damaging circuit boards.
- ▶ Allow at least 0.1" air gap when bolting EZStepper to mounting plate, for cooling.
- ▶ DO NOT disconnect motor wires while power is on, to avoid damage to circuit board.
- ▶ DO NOT place exposed circuit boards on metal surface when powered (to prevent shorts).
- ▶ Avoid bundling encoder or IO wires with motor power wires, as this may cause noise pickup from motor wires. If bundling is necessary, put motor wires in a separate shielded twisted-pair cable.
  - For 10' or longer, shield each IO line individually.
  - If using ribbon cable, add grounds between signal wires and motor wires.

### Starting Up Using USB Port Connection

NOTE: See next page for starting up using EZ Bus connection.

Start with power supply OFF.

1. Download and install the EZCommander™ application from [www.allmotion.com/support/EZStepper](http://www.allmotion.com/support/EZStepper) Windows Application. (Use your own terminal program for Mac or Linux. Some instructions may not apply.)
2. Download and install appropriate USB driver from [www.allmotion.com/support](http://www.allmotion.com/support).
3. *Ensure power is OFF.* Connect power supply to the EZStepper. (See Wiring Note also.)
4. Turn power ON. Confirm that green Life LED slowly blinks. If not, look for bad power connection.
5. Set address switch firmly to number 1 with Philips screwdriver.
6. Cycle power OFF/ON if address switch was moved in preceding step.
7. *With USB cable to PC unplugged:* Start the EZCommander application (see other side of sheet for instructions if needed). Click 'Settings,' then "Re-scan Ports." Note available ports, then click "OK."
8. Connect EZStepper to a PC USB port with cable (included in starter kit).
9. In EZCommander, click "Settings," then "Re-Scan Ports." Select the new port that becomes available, and click "OK." If no new port appears, a problem with the USB driver is indicated. Re-install the driver for your system.
10. In EZCommander, click "Send String 0" to issue the command "/1&." Confirm return message showing product name and firmware version. If return message says "No EZStepper Detected," troubleshoot communications (page 3) before connecting motor.
11. *With power OFF,* connect stepper motor as shown in the diagram. (See Wiring Note also.)
12. Turn power ON.
13. In EZ Commander, issue the command "/1A1000A0R." Confirm that motor rotates back and forth.

**You're on your way!** For other commands and hookups, see the full user guide and wiring diagram on the AllMotion® website.

**Troubleshooting:** See last page. →

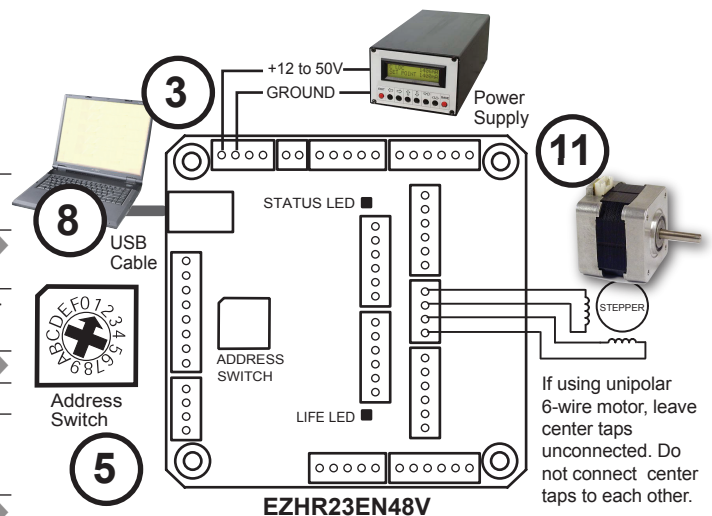

### CAUTION!

Do not connect or disconnect motor with power applied.

Unplugging of or intermittent connection to an inductive load causes a high-voltage spark, which will damage the driver.

### Wiring Note

Always wire to the mating connectors supplied on circuit board. Use crimp tool if you have it, or else solder. (DO NOT solder to circuit board; damage is likely. Also, DO NOT press in with a screwdriver, because this makes unreliable connections.)

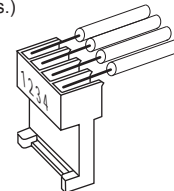

## Starting Up Using EZ Bus Connections

NOTE: If using RS232-to-RS485 Converter, disregard instructions for USB.

Start with power supply OFF.

- Download and install the EZCommander™ application from [www.allmotion.com/support/EZStepper Windows Application](http://www.allmotion.com/support/EZStepper Windows Application). (Use your own terminal program for Mac or Linux. Some instructions may not apply.)
- If using USB-to-RS485 Converter as shown, download and install appropriate USB driver from [www.allmotion.com/support](http://www.allmotion.com/support).
- Ensure power is OFF. Connect power supply to RS485 Converter. →
- Connect EZ Stepper to RS485 converter. →
  - If using EZ Start kit, use cable provided. If not using kit, wire mating 4-pin connectors pin-to-pin per the markings on the connector, for example pin A to pin A. (See Wiring Note also.)
  - Turn power ON. Confirm that green Life LED slowly blinks. If not, look for bad power connection.
- Set address switch firmly to number 1 with Philips screwdriver. →
- Cycle power OFF/ON if address switch was moved in preceding step.
- With USB cable from Converter to PC unplugged: Start the EZCommander application (see other side of sheet for instructions if needed). Click "Settings," then "Rescan Ports." Note available ports, then click "OK."
- Connect RS485 Converter to a PC USB port with the cable (supplied with converter). →
- In EZCommander, click "Settings," then "Re-Scan Ports." Select the new port that becomes available, and click "OK." (For RS232 converter, the new port will be com1.) If no new port appears, a problem with the USB driver is indicated. Re-install the driver for your system.
- In EZCommander, click "Send String 0" to issue the command "/1&." Confirm return message showing product name and firmware version. If return message says "No EZStepper Detected," troubleshoot communications (page 3) before connecting motor.
- With power OFF, connect stepper motor as shown in the diagram. (See Wiring Note also.) →
- Turn power ON.
- In EZCommander, issue the command "/1A1000A0R." Confirm that the motor rotates back and forth.

**You're on your way!** For other commands and hookups, see the full user guide and wiring diagram on our website.

**Troubleshooting:** See next page. →

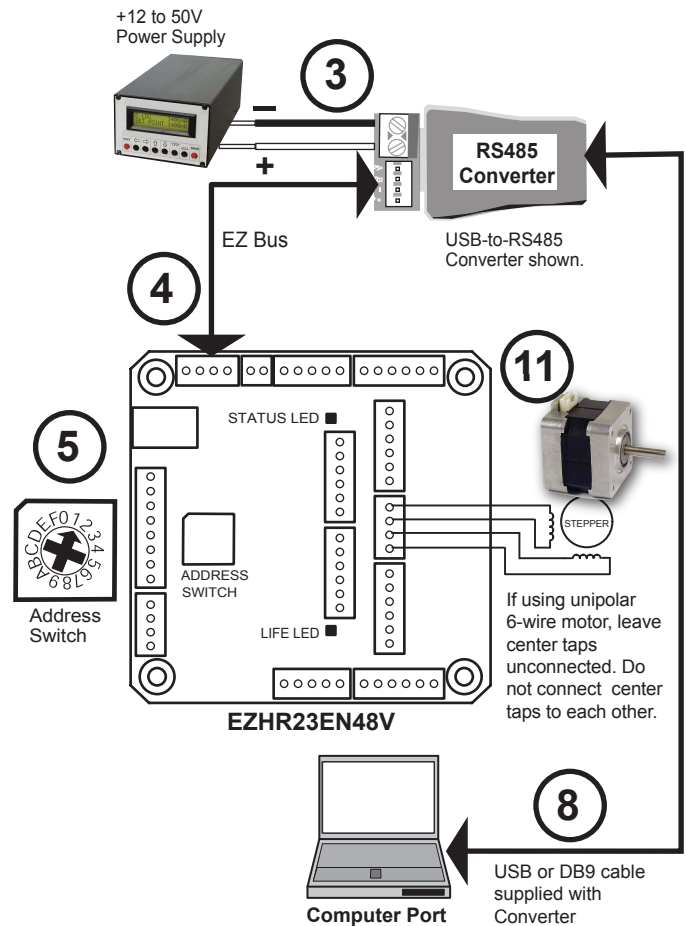

### CAUTION!

Do not connect or disconnect motor with power applied.

Unplugging of or intermittent connection to an inductive load causes a high-voltage spark, which will damage the driver.

### Wiring Note

Always wire to the mating connectors supplied on circuit board. Use crimp tool if you have it, or else solder. (DO NOT solder to circuit board; damage is likely. Also, DO NOT press in with a screwdriver, because this makes unreliable connections.)

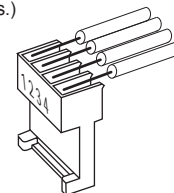

Using EZCommander™

Start with communications cable unplugged.

NOTE: If using RS232 Converter, disregard instructions for USB.

1 Open EZCommander.



2 Click the **Settings** button to open the Communications window.

- Click Re-Scan Ports; note available ports; then click OK to close.

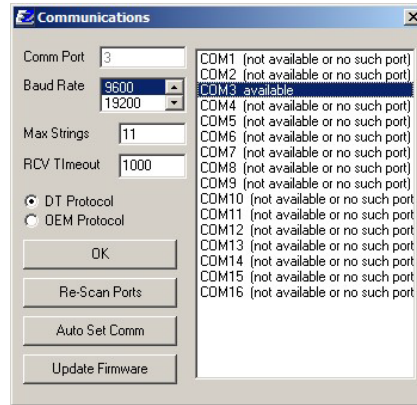

NOTE: USB cable is disconnected for this step.

3 Plug USB cable into the PC.

- Click Settings button, then Re-scan Ports. A new comm port will become available (will be com1 if using RS232 Converter).
- Select the newly available comm port and click OK to close the Communications Window.

4 Issue commands :

- Enter string in a left-hand field.
- Press adjacent **Send String** button to issue command.
- See return message in field to right.

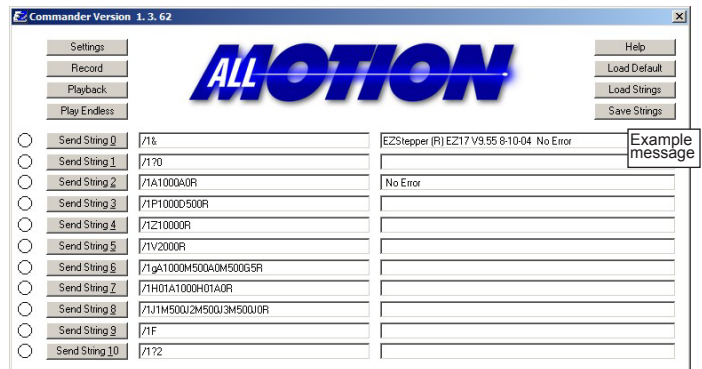
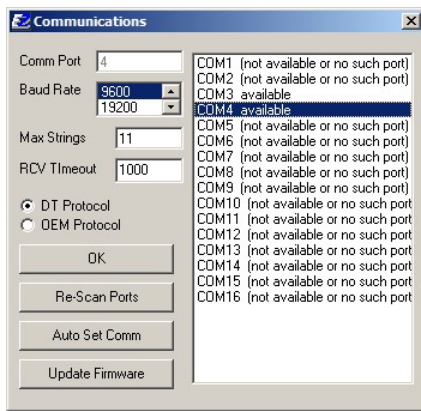

Command strings ↑

Return messages ↑

Troubleshooting

If motor does not respond to commands:

- Make sure address switch is detented exactly on position number 1. (After resetting, power must be cycled to establish new address.)
- Re-check that correct com port is selected.
- Confirm good ground between PC and negative terminal of power supply. First, measure resistance with power off; then check for voltage drop with power on. Repair poor ground connections.
- Issue command "/!&" and verify that a response identifying the product and firmware version is received. If ok, motor connection may be miswired or loose. If not ok, re-install USB driver. Continue to next item if not resolved.
- Check continuity of communication data to EZStepper board at point 1 in diagram below. If not present, check at other points indicated. Suspect failed component or faulty wiring/connector between point where signal is absent and last point where signal is present.

If motor misses steps at high speed:

- Increase either the Move current or the supply voltage. To increase Move current, issue an "m" for Fast Move Current and/or "I" command (lower case L) for Slow Move Current. Example: /!m75 = set current to 75% max. Step misses typically happen in the middle of a move, where the motor "catches" in the beginning and end, but stalls in the middle.

If motor direction is not consistent:

- Check that coils of motor are securely connected at both ends. This is typically caused when one of the coils has a loose connection.

